

Sistema Landscape Tilt

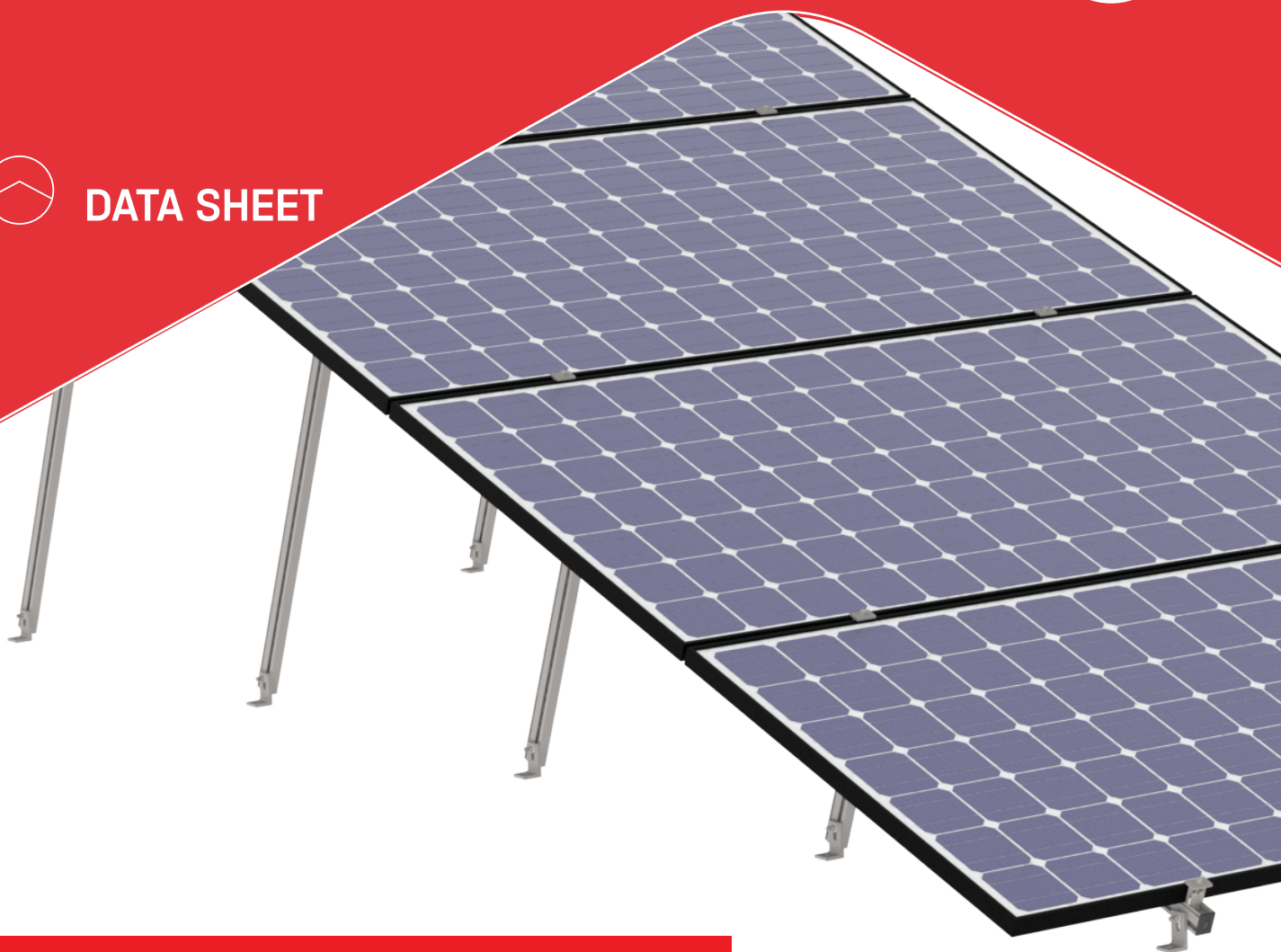

DATA SHEET



CARACTERÍSTICAS DEL PRODUCTO

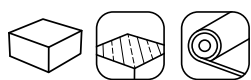

/ Sistema de alta calidad optimizado para instalaciones residenciales en techos estrechos.

/ Configuraciones para vientos de hasta 240 km/h.

/ Inclinaciones de módulos de 7° - 25°

/ Instalación de arreglos 4x1 Landscape.

/ Validación estructural de acuerdo a norma ASCE 7-16.

/ Instalación simplificada para mejorar tiempos de instalación.

INFORMACIÓN TÉCNICA

Sistema Landscape Tilt	
Tipo de techo	Plano, Concreto
Material	Acero inoxidable de alta resistencia a corrosión y aluminio grado marino.
Terminado	Mill
Conexión al techo	Anclaje para concreto de hasta 3/8".
Flexibilidad	Prediseñado para arreglo de 4x1 a inclinaciones de 7° - 25°
Orientación de paneles	Landscape
Diseño	ASCE 7-16
Garantía	25 años

Dimensiones de instalación Landscape Tilt

El Sistema Landscape Tilt ofrece diferentes configuraciones para optimizar instalación en un rango de velocidades.

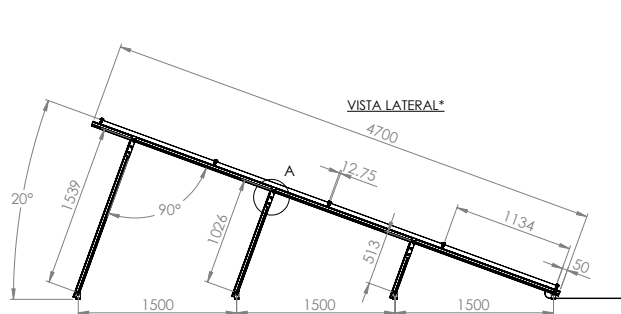

Modelo de 3 soportes.

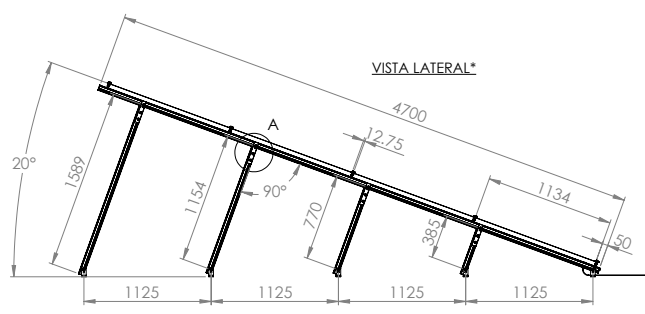

Modelo de 4 soportes.

Wind (km/h)	10°	15°	20°	25°
60	3	3	3	3
70	3	3	3	3
80	3	3	3	3
90	3	3	3	3
100	3	3	3	3
110	3	3	3	3
120	3	3	3	3
130	3	3	3	3
140	3	3	3	3
150	3	3	3	3
160	3	3	3	3
170	4	3	3	3
180	4	4	3	3
190	4	4	3	3
200	4	4	4	3
210	4	4	4	3
220		4	4	4
230		4	4	4
240			4	4

Modelo a utilizar de acuerdo a la velocidad

Components

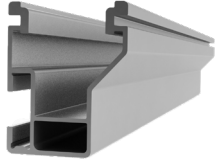

CrossRail 48-X

Número de parte	Descripción
4000025	CrossRail 48-X, 2.11 m, Rail, Mill
4000024	CrossRail 48-X, 3.15 m, Rail, Mill
4000199	CrossRail 48-X, 4.6 m, Rail, Mill
4000671	CrossRail 48-X, 4.22 m, Rail, Mill
4000674	CrossRail 48-X, 4.27 m, Rail, Mill
4000669	CrossRail 48-X, 4.70 m, Rail, Mill
4000724	CrossRail 48-X, 4.369 m, Rail, Mill



L-Foot

Número de parte	Descripción
4000630	L-Foot Slotted Set, Mill



K2 Cross Clamp Set, Mill

Número de parte	Descripción
4000135	K2 Cross Clamp Set, Mill



Tilt Connector Set

Part Number	Descripción
4000505	CrossRail Tilt Connector Set

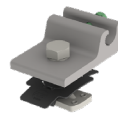

Ground Lug

Part Number	Descripción
4000006-H	K2 Ground Lug, 13mm Hex Set



MLPE Frame Mount KIT

Part Number	Descripción
4000083	MLPE, Module Frame Mount, Kit



Wire Management

Part Number	Description
4000069	Wire Management Clip, TC
4000400	K2 4 Wire Dragon Clip, Set



End Cap

Part Number	Descripción
4000176	EndCap 44-X , K2



Optimizer Mounting Kit

Part Number	Descripción
4000629-H	CR Micro inverter & OPT, 13mm Hex Kit



Connecting Strength

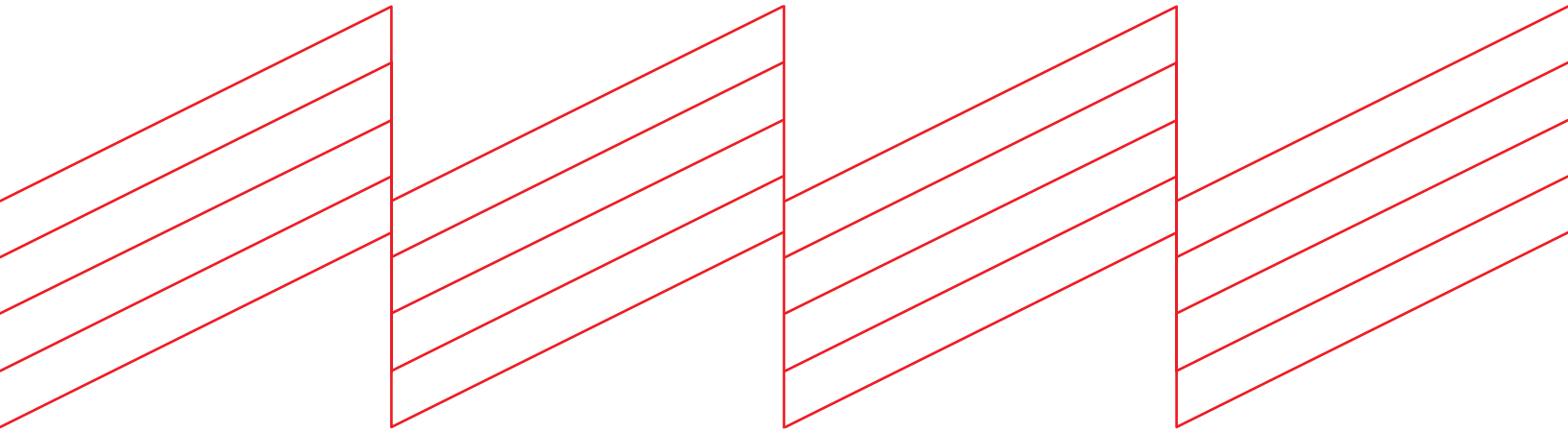

K2 Systems México

K2 Systems México · Prol. Av. el Colli Bodega 17 Col.
Paraísos del Colli, C.P. 45069 Zapopan, Jal. • México

+52.33.3575.9380 • info@k2-systems.mx

www.k2-systems.com/es-mx

Landscape Tilt Data Sheet ESV1 | 0226 • Sujeta a cambios

Las ilustraciones del producto son ejemplares y pueden diferir del original.